

JVC

SCHEMATIC DIAGRAMS

COLOUR TELEVISION

AV-21F9_(NS)

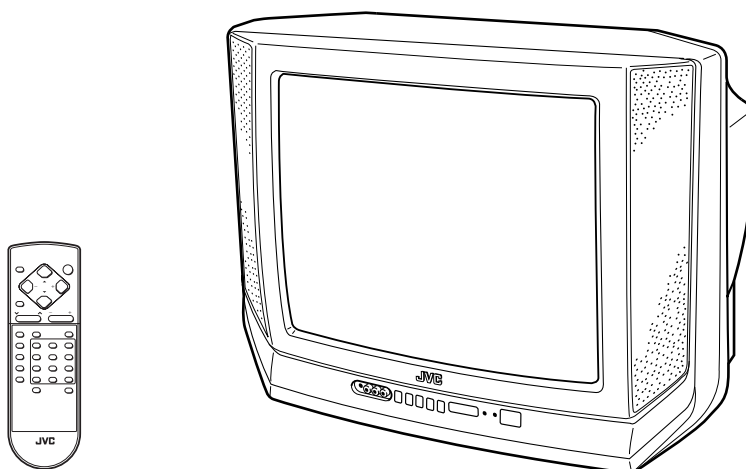

STANDARD CIRCUIT DIAGRAM

NOTE ON USING CIRCUIT DIAGRAMS

1. SAFETY

The components identified by the Δ symbol and shading are critical for safety. For continued safety replace safety critical components only with manufactures recommended parts.

2. SPECIFIED VOLTAGE AND WAVEFORM VALUES

The voltage and waveform values have been measured under the following conditions.

- (1) Input signal : Colour bar signal
- (2) Setting positions of each knob/button and variable resistor : Original setting position when shipped
- (3) Internal resistance of tester : DC 20k Ω /V
- (4) Oscilloscope sweeping time : H \rightarrow 20 μ S/div
: V \rightarrow 5mS/div
: Others \rightarrow Sweeping time is specified.
- (5) Voltage values : All DC voltage values

* Since the voltage values of signal circuit vary to some extent according to adjustments, use them as reference values.

3. INDICATION OF PARTS SYMBOL [EXAMPLE]

- In the PW board : R1209 \rightarrow R209

4. INDICATIONS ON THE CIRCUIT DIAGRAM

(1) Resistors

- Resistance value

No unit	: [Ω]
K	: [K Ω]
M	: [M Ω]

- Rated allowable power

No indication	: 1/4 [W]
Others	: As specified

- Type

No indication	: Carbon resistor
OMR	: Oxide metal film resistor
MFR	: Metal film resistor
MPR	: Metal plate resistor
UNFR	: Non-flammable resistor
FR	: Fusible resistor

* Composition resistor 1/2 [W] is specified as 1/2S or Comp.

(2) Capacitors

- Capacitance value

1 or higher	: [pF]
less than 1	: [μ F]

- Withstand voltage

No indication	: DC50 [V]
AC indicated	: AC withstand voltage [V]
Others	: DC withstand voltage [V]

* Electrolytic Capacitors

47/50 [Example]: Capacitance value [μ F]/withstand voltage [V]

- Type

No indication	: Ceramic capacitor
MY	: Mylar capacitor
MM	: Metalized mylar capacitor
PP	: Polypropylene capacitor
MPP	: Metalized polypropylene capacitor
MF	: Metalized film capacitor
TF	: Thin film capacitor
BP	: Bipolar electrolytic capacitor
TAN	: Tantalum capacitor

(3) Coils



No unit	: [μ H]
Others	: As specified

(4) Power Supply



	: B1
	: 12V
	: 9V
	: 5V

* Respective voltage values are indicated.



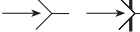

(5) Test point

	: Test point
	: Only test point display

(6) Connecting method

	: Connector
	: Wrapping or soldering
	: Receptacle

(7) Ground symbol

	: LIVE side ground
	: ISOLATED (NEUTRAL) side ground
	: EARTH ground
	: DIGITAL ground

5. NOTE FOR REPAIRING SERVICE

This model's power circuit is partly different in the GND. The difference of the GND is shown by the LIVE (\perp) side GND and the ISOLATED (NEUTRAL) (\nearrow) side GND. Therefore, care must be taken for the following points.

- (1) Do not touch the LIVE side GND or the LIVE side GND and the ISOLATED (NEUTRAL) side GND simultaneously. If the above caution is not respected, an electric shock may be caused. Therefore, make sure that the power cord is surely removed from the receptacle when, for example, the chassis is pulled out.
- (2) Do not short between the LIVE side GND and ISOLATED (NEUTRAL) side GND or never measure with a measuring apparatus (oscilloscope, etc.) the LIVE side GND and ISOLATED (NEUTRAL) side GND at the same time. If the above precaution is not respected, a fuse or any parts will be broken.

- Since the circuit diagram is a standard one, the circuit and circuit constants may be subject to change for improvement without any notice.

CONTENTS

SEMICONDUCTOR SHAPES 2-4

BLOCK DIAGRAM 2-5

CIRCUIT DIAGRAMS

MAIN PWB CIRCUIT DIAGRAM 2-7

AV SW PWB CIRCUIT DIAGRAM 2-9

IF PWB CIRCUIT DIAGRAM 2-11

CRT SOCKET PWB CIRCUIT DIAGRAM 2-13

FRONT CONTROL PWB CIRCUIT DIAGRAM 2-15

PATTERN DIAGRAMS

FRONT CONTROL PWB PATTERN 2-16

MAIN PWB PATTERN 2-17





AV SW PWB PATTERN 2-19

IF PWB PATTERN 2-20

CRT SOCKET PWB PATTERN 2-21

SEMICONDUCTOR SHAPES

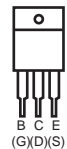
TRANSISTOR

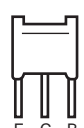
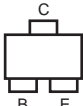
BOTTOM VIEW	FRONT VIEW				TOP VIEW
					CHIP TR 

IC

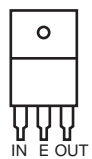
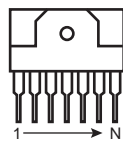
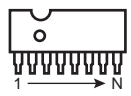
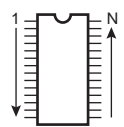
BOTTOM VIEW	FRONT VIEW			TOP VIEW
				

CHIP IC

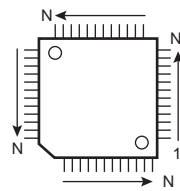
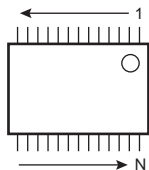
TOP VIEW		
		

BLOCK DIAGRAM

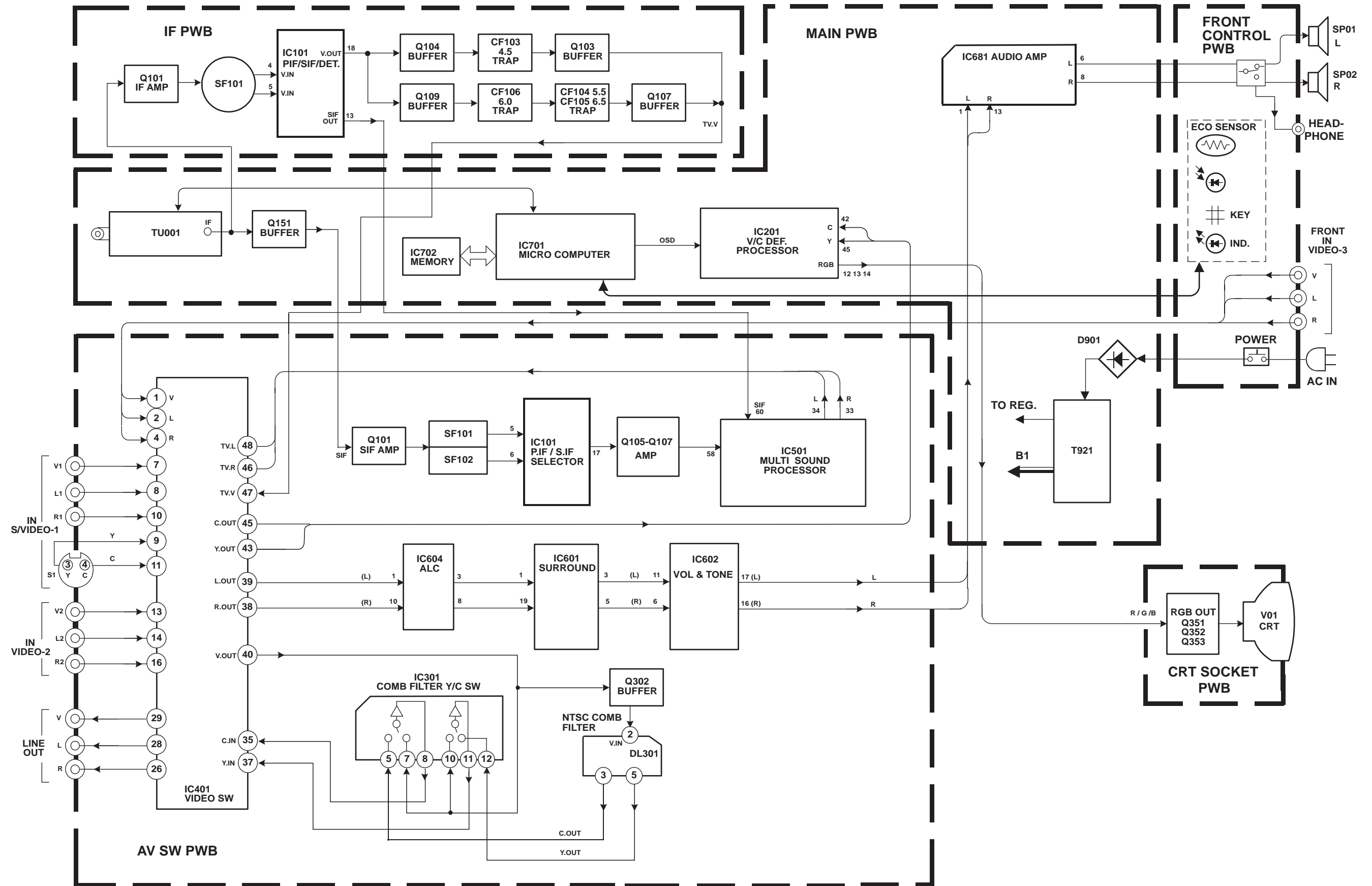

AV SW PWB CIRCUIT DIAGRAM

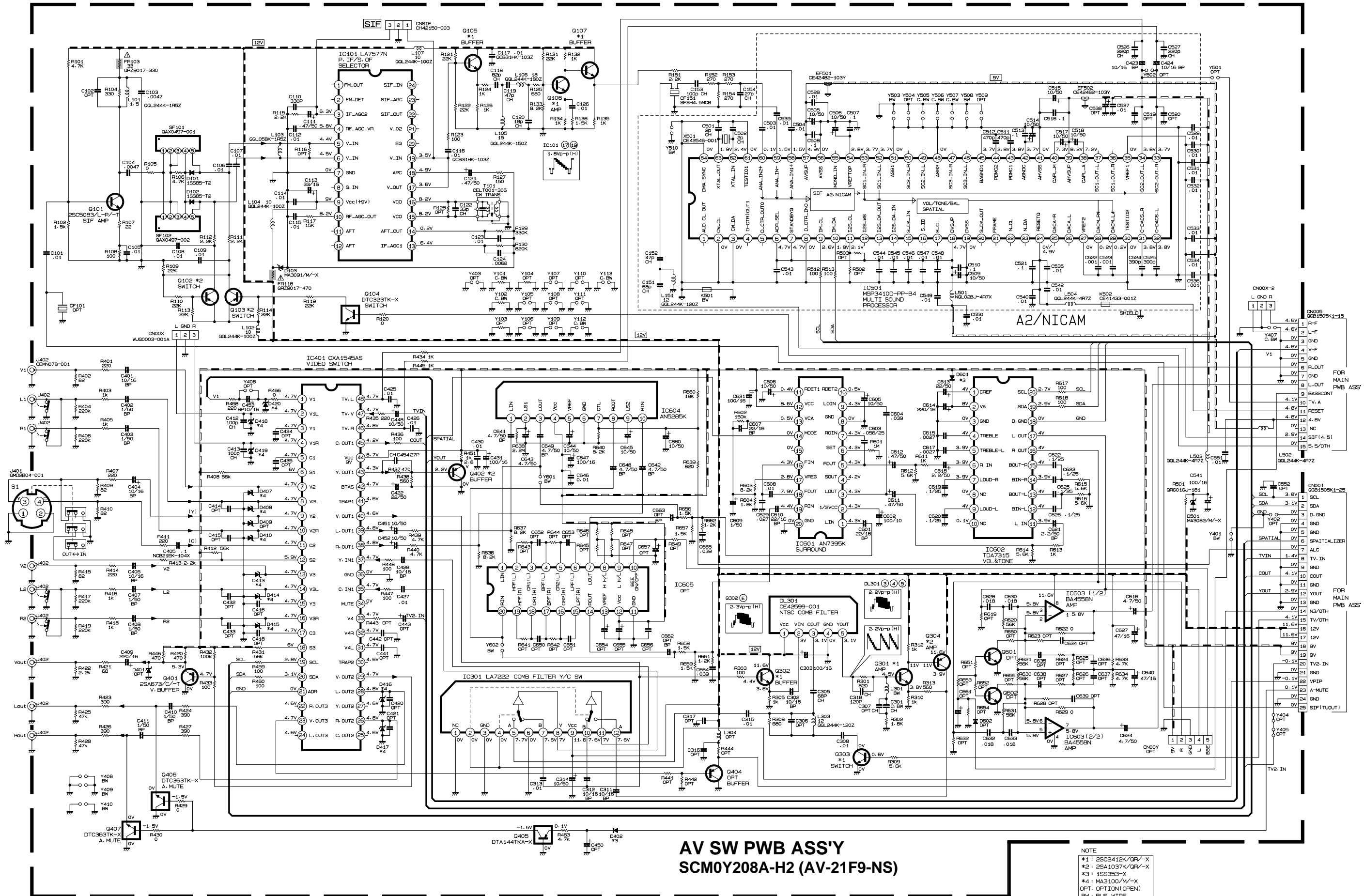

AV SW PWB ASS'Y
SCM0Y208A-H2 (AV-21F9-NS)

NOTE

- *1 : 2SC2412K/QR/-X
- *2 : 2SA1037K/QR/-X
- *3 : 1SS353-X
- *4 : MA3100/W/-X
- OPT: OPTION(OPEN)
- BW : BUS WIFE

IF PWB CIRCUIT DIAGRAM

* PARTS

* AV-21F9 -NS
C113 OPT
C124 OPT
Q111 OPT
R113 0
SF102 OPT
C601 OPT
C602 OPT
C603 OPT
C604 OPT
C606 OPT
C607 OPT
C608 OPT
C609 OPT
C610 OPT
C611 OPT
C612 OPT

* PARTS

* AV-21F9 -NS
CF601 OPT
CF604 OPT
CF606 OPT
CF608 OPT
L601 OPT
Q601 OPT
Q602 OPT
Q603 OPT
Q604 OPT
Q605 OPT
Q606 *2
Q608 OPT

* PARTS

* AV-21F9 -NS
R601 OPT
R602 OPT
R604 OPT
R605 OPT
R606 OPT
R607 OPT
R608 OPT
R609 OPT
R610 OPT
R611 OPT
R612 OPT
R615 OPT
R616 OPT
R617 OPT
R619 1k
R620 OPT

* PARTS

* AV-21F9 -NS
R621 OPT
R622 OPT
R623 OPT
R624 OPT
R625 OPT
R626 OPT
R627 OPT
R628 OPT
C130 OPT
C131 OPT

IF PWB ASS'Y
SCM0F201A-H2 (AV-21F9-NS)

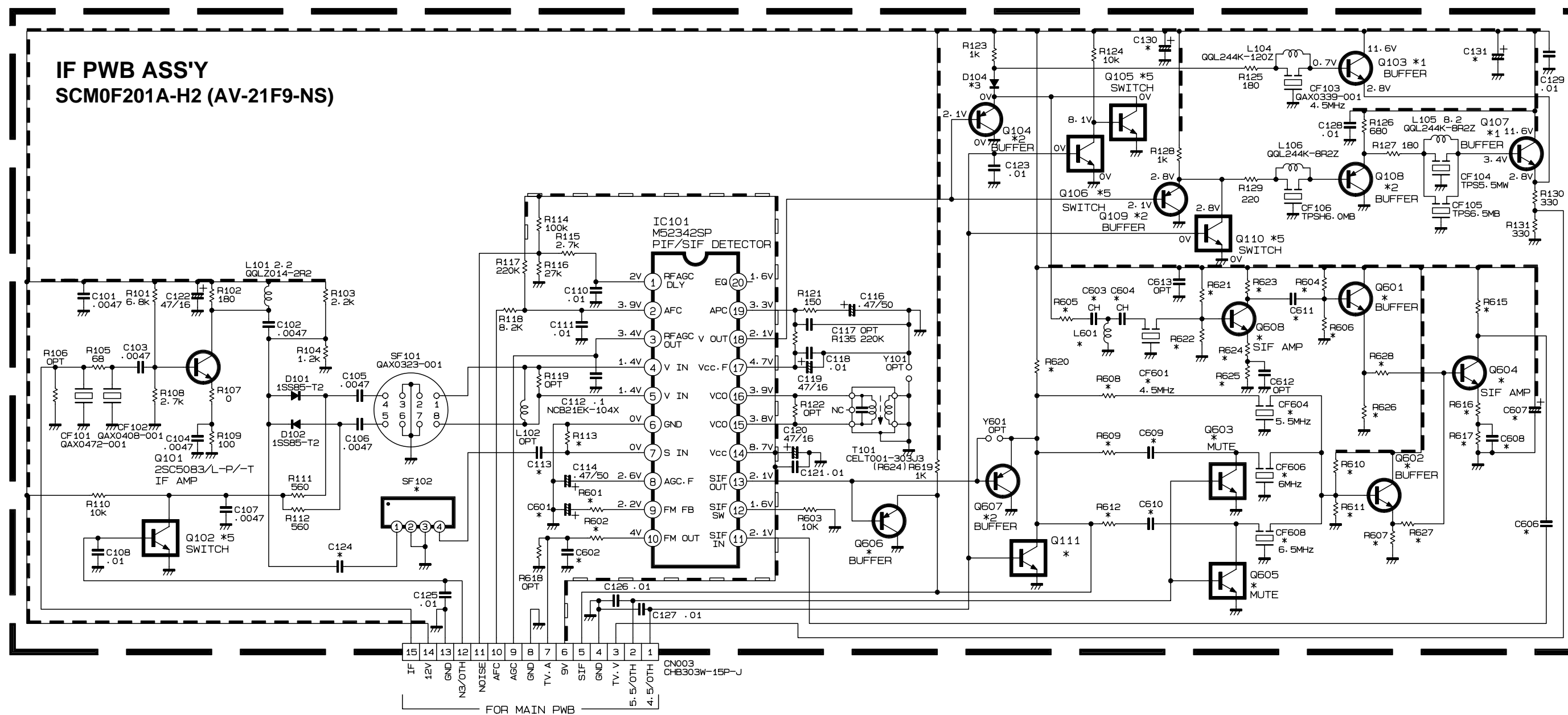

CRT SOCKET CIRCUIT DIAGRAM

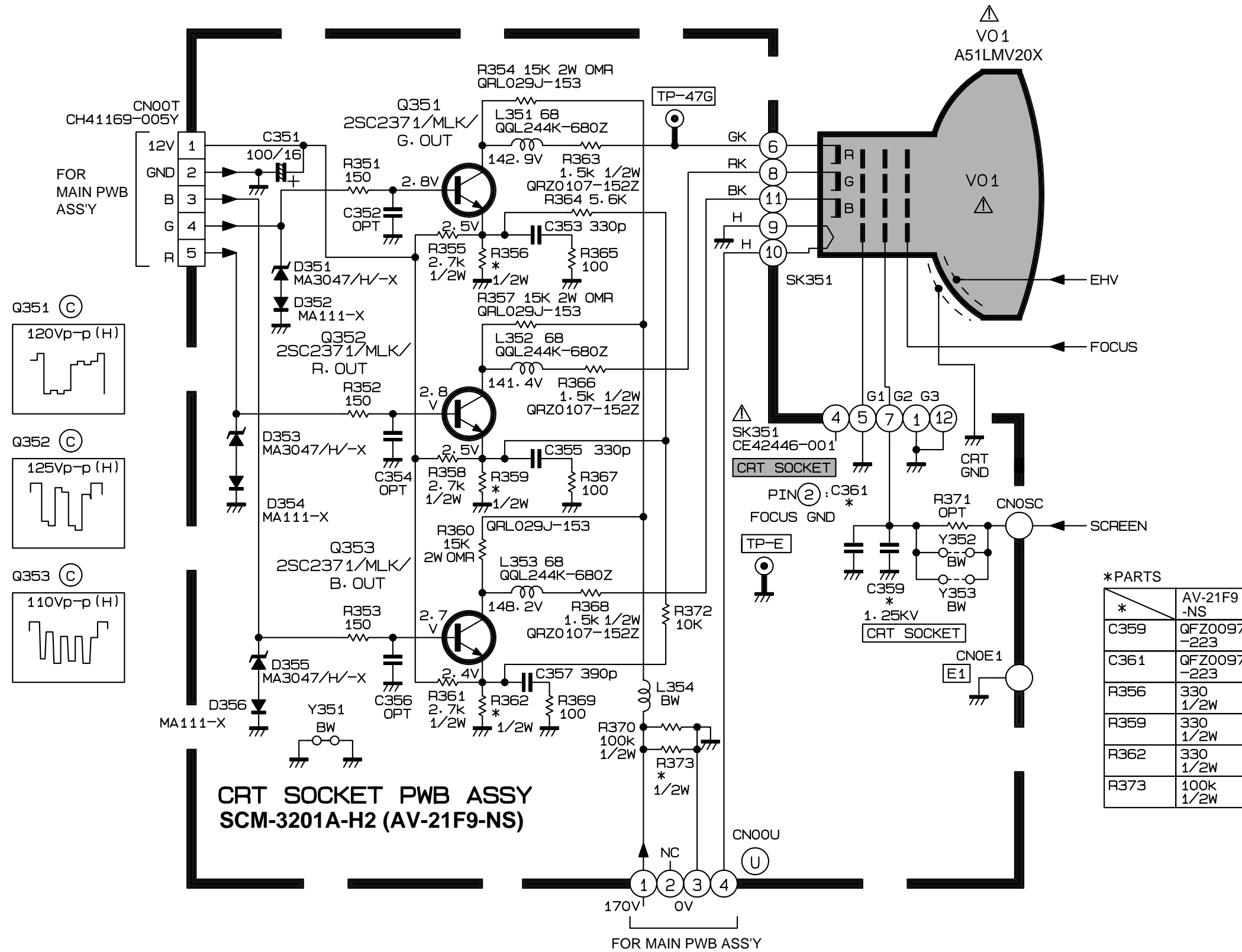

CRT SOCKET PWB PATTERN

TOP

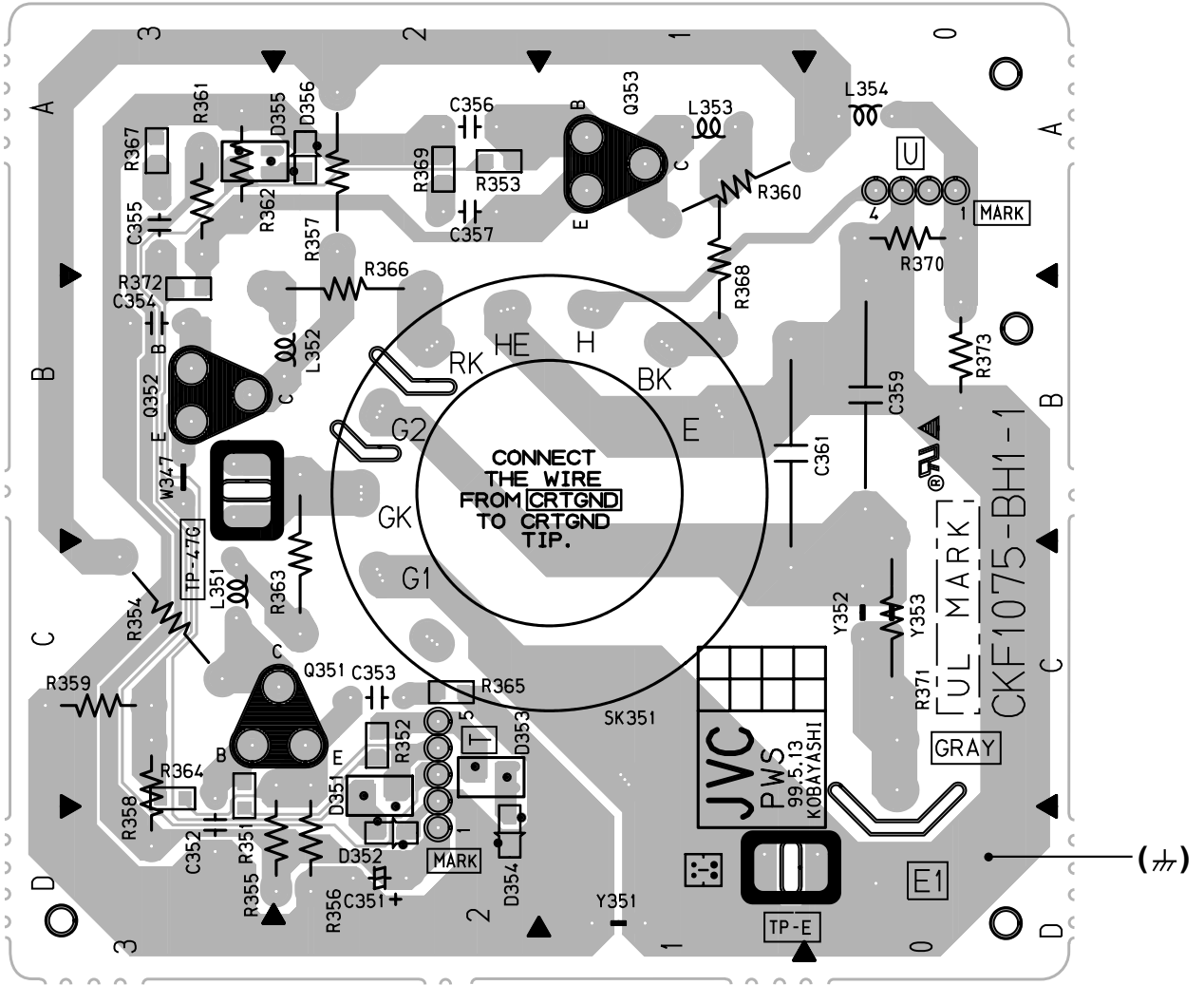



JVC

VICTOR COMPANY OF JAPAN, LIMITED

TELEVISION RECEIVER DIVISION 1106 Heta, Iwai-city, Ibaraki-prefecture, 306-0698, Japan



Printed in Japan
CTH 0008
CRT